

ATF 40G-2

40 TON MAX. LIFTING CAPACITY

EUROMOT 3A

**ALL
TERRAIN
CRANE**



Maße (mm)
 Dimensions (mm)
 Dimensiones (mm)

385/95 R 25
 (14.00 R 25)

DIN/ISO/EN

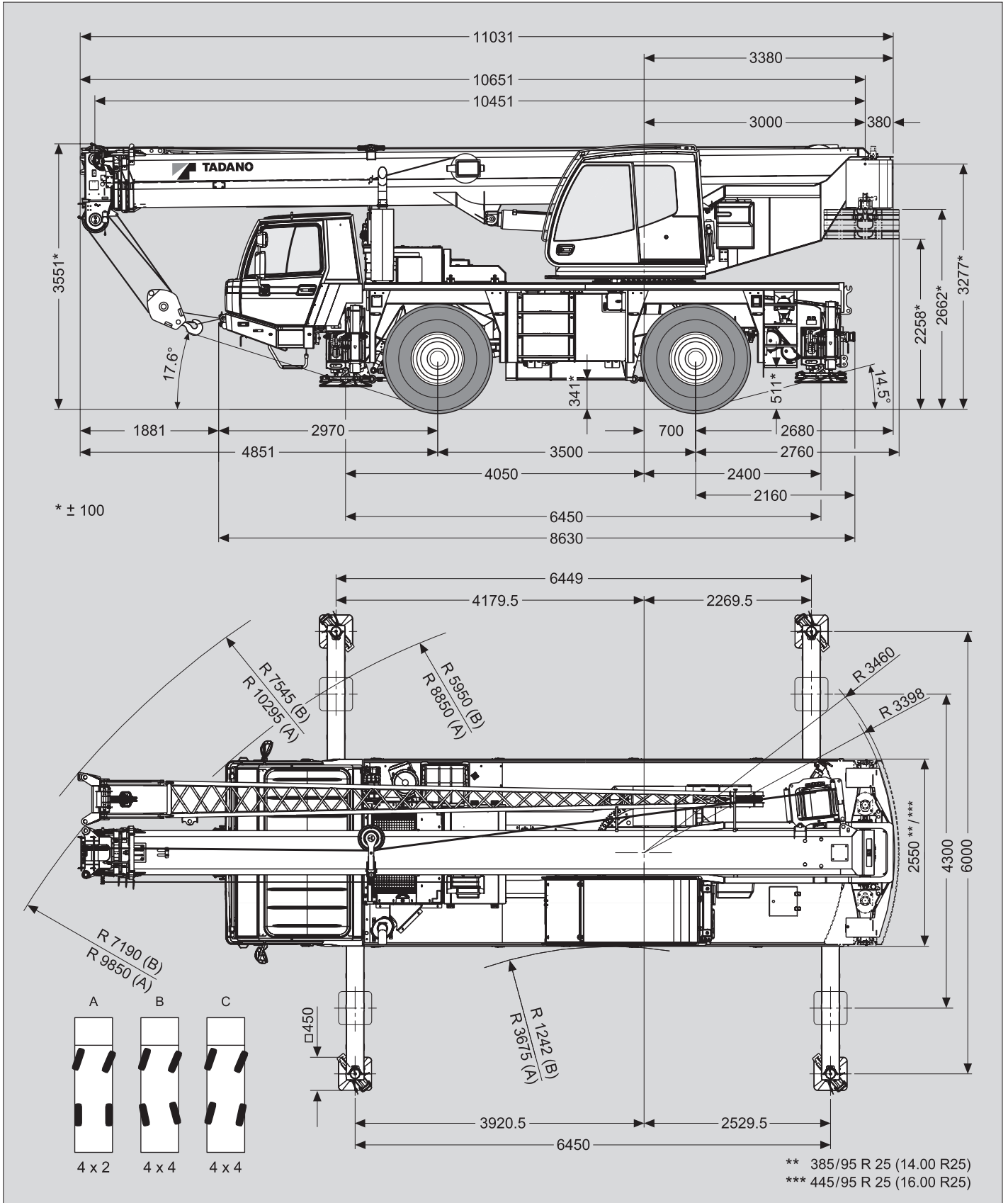

Hubhöhen
Lifting heights
Hauteurs de levage
Alturas de elevación

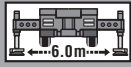
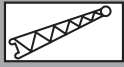
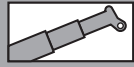

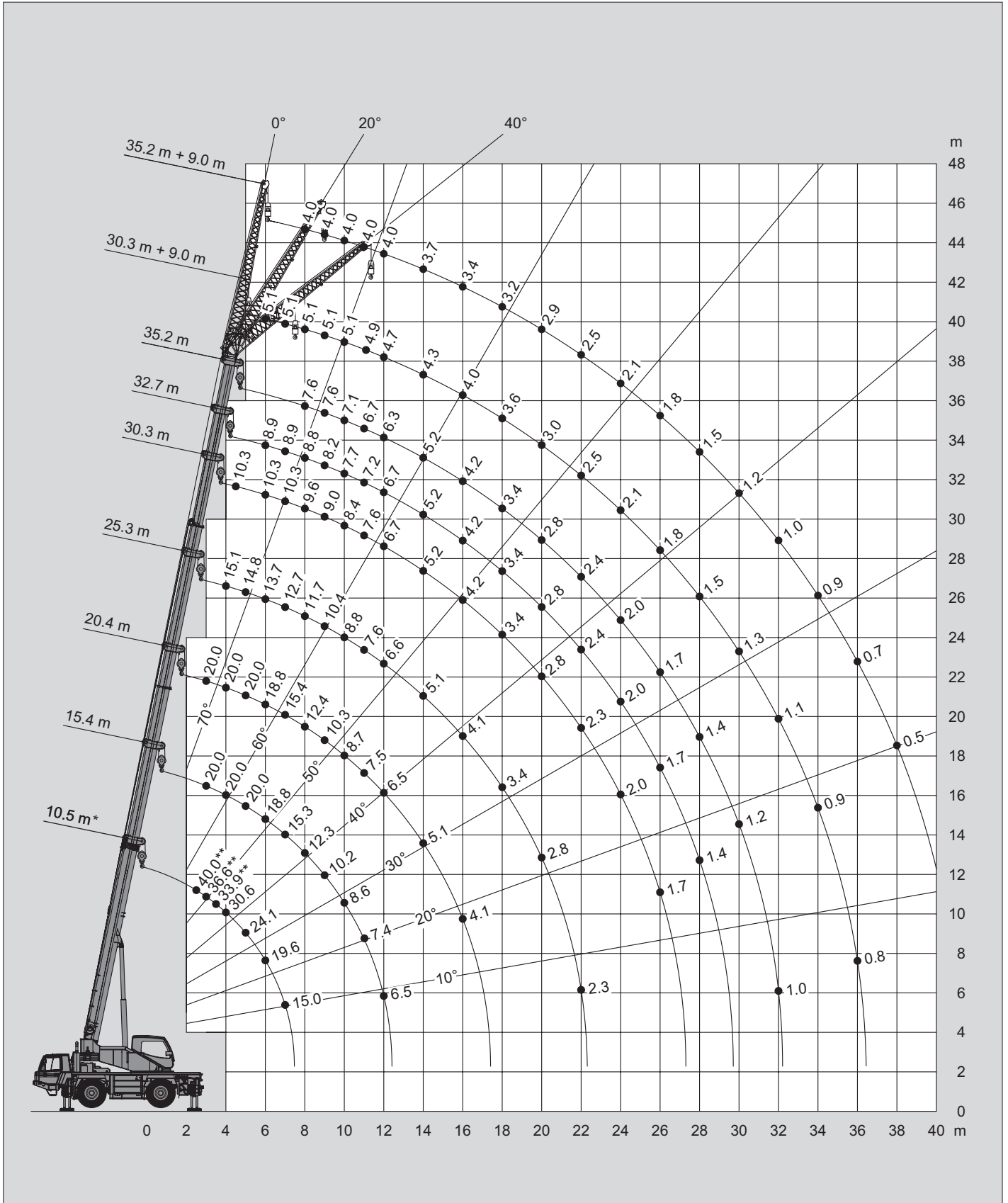

6.5t

DIN/ISO/EN



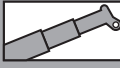
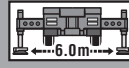

Tragfähigkeiten
Lifting capacities
Capacités de levage
Capacidades de elevación

   6.5t		DIN/ISO/EN						
 m	10.5 m*	10.5 m	15.4 m	20.4 m	25.3 m	30.3 m	32.7 m	35.2 m
2.5	40.0**							
3.0	36.6**	32.1**	20.0	20.0	15.1			
3.5	33.9**	29.0	20.0	20.0	15.1			
4.0	30.6	26.4	20.0	20.0	15.1			
4.5	27.0	24.2	20.0	20.0	15.1	10.3		
5.0	24.1	22.2	20.0	20.0	14.8	10.3		
6.0	19.6	18.6	18.8	18.8	13.7	10.3	8.9	7.6
7.0	15.0	15.0	15.3	15.4	12.7	10.3	8.9	7.6
8.0			12.3	12.4	11.7	9.6	8.8	7.6
9.0			10.2	10.3	10.4	9.0	8.2	7.6
10.0			8.6	8.7	8.8	8.4	7.7	7.1
11.0			7.4	7.5	7.6	7.6	7.2	6.7
12.0			6.5	6.5	6.6	6.7	6.7	6.3
14.0				5.1	5.1	5.2	5.2	5.2
16.0				4.1	4.1	4.2	4.2	4.2
18.0					3.4	3.4	3.4	3.4
20.0					2.8	2.8	2.8	2.8
22.0					2.3	2.3	2.4	2.4
24.0						2.0	2.0	2.0
26.0						1.7	1.7	1.7
28.0							1.4	1.4
30.0								1.2
32.0								1.0

* Nach hinten / * Over rear / * A l'arrière / * Sobre la parte trasera

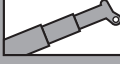
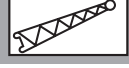
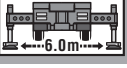
** Mit Zusatzhubausrüstungen / ** With additional lifting equipments / ** Avec équipements supplémentaires / ** Con equipos adicionales

    6.5t		DIN/ISO/EN								
 m	10.5 m + 9.0 m			30.3 m + 9.0 m			35.2 m + 9.0 m			
	0°	20°	40°	0°	20°	40°	0°	20°	40°	
3.0	6.5									
3.5	6.5									
4.0	6.5	6.5								
4.5	6.5	6.5								
5.0	6.5	6.4								
6.0	6.5	6.0		5.1						
7.0	6.5	5.6	4.7	5.1						
8.0	6.4	5.4	4.5	5.1			4.0			
9.0	6.0	5.1	4.4	5.1	4.6		4.0			
10.0	5.6	4.9	4.2	5.1	4.4		4.0			
11.0	5.3	4.6	4.1	4.9	4.2		4.0	3.7		
12.0	5.1	4.4	4.0	4.7	4.1	3.8	4.0	3.5		
14.0	4.6	4.1	3.9	4.3	3.8	3.5	3.7	3.3	3.1	
16.0	4.2	4.0		4.0	3.6	3.3	3.4	3.1	2.9	
18.0				3.6	3.4	3.2	3.2	2.9	2.8	
20.0				3.0	3.2	3.0	2.9	2.8	2.6	
22.0				2.5	2.7	2.8	2.5	2.6	2.5	
24.0				2.1	2.3	2.4	2.1	2.3	2.4	
26.0				1.8	1.9	2.0	1.8	1.9	2.0	
28.0				1.5	1.6	1.7	1.5	1.6	1.7	
30.0				1.3	1.4	1.4	1.2	1.4	1.4	
32.0				1.1	1.1		1.0	1.1	1.2	
34.0				0.9	0.9		0.9	0.9	1.0	
36.0				0.8			0.7	0.8		
38.0							0.5	0.6		